



QUICK INSTALLATION GUIDE

RAILING SERIES
SURFACE OPTION

acristalia

ONE PROFILE, THREE SOLUTIONS

The versatility of our Railing Series railing system is already well known, offering the possibility of adapting to any surface depending on the type of installation required, offering three basic types of solutions:

- **embedded**, which inserts the profile on site by screwing it into the base, leaving only the glass and the rubber seals at the top visible;
- **surface**, in which the profile is screwed onto the floor, providing extra protection for the glass in the form of a plinth;
- **side**, where the profile is screwed to the wall on the outside and an aesthetic cover profile is attached.

EMBEDDED SOLUTION

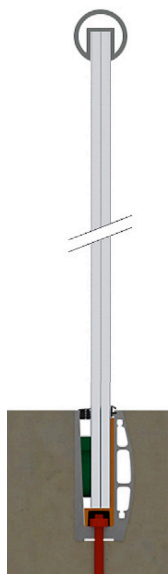

SURFACE SOLUTION

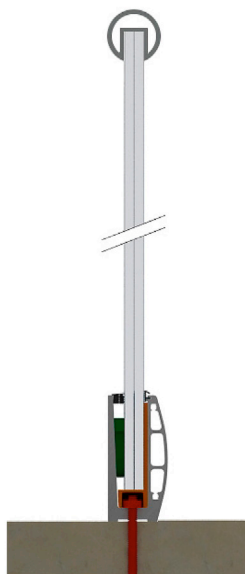

SIDE SOLUTION

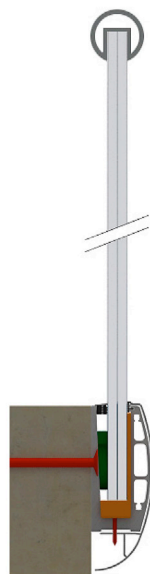

In addition, thanks to the compatibility of the Railing & Basic Pro Series, the two products can be integrated into one installation. The railing is equipped with a handrail that serves as a guide for the glass curtain. All profiles are customisable, offering a comprehensive solution, as we have a wide catalogue of brackets, components, glass alignment parts and accessories that will turn any idea into a reality to be leaned on.

On this occasion, we are going to show the correct way to install the surface solution, in which, following a few simple steps, our Acristalia Railing Series railing can be installed without difficulty. following a few simple steps, you will be able to install our Acristalia Railing Series railing without any difficulty.

STEPS

1. Option A: Maximum performance direct bolted anchorage for 8 x 85 mm or similar concrete fixings. Distance between fixings 150 mm and 50 mm at the ends.

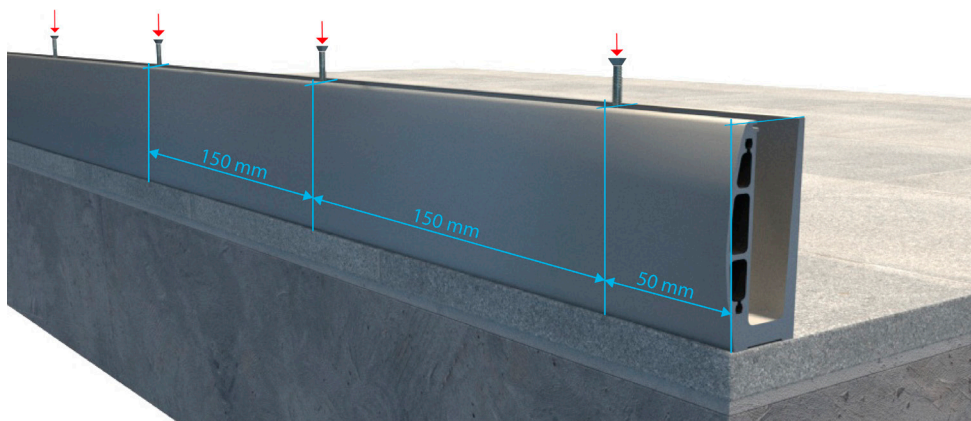

1. Option B: Resin chemical compound anchorage and one M10 threaded rod, embedded 120 mm, overhanging 25 mm. Distance between fixings 150 mm and 50 mm at the ends.

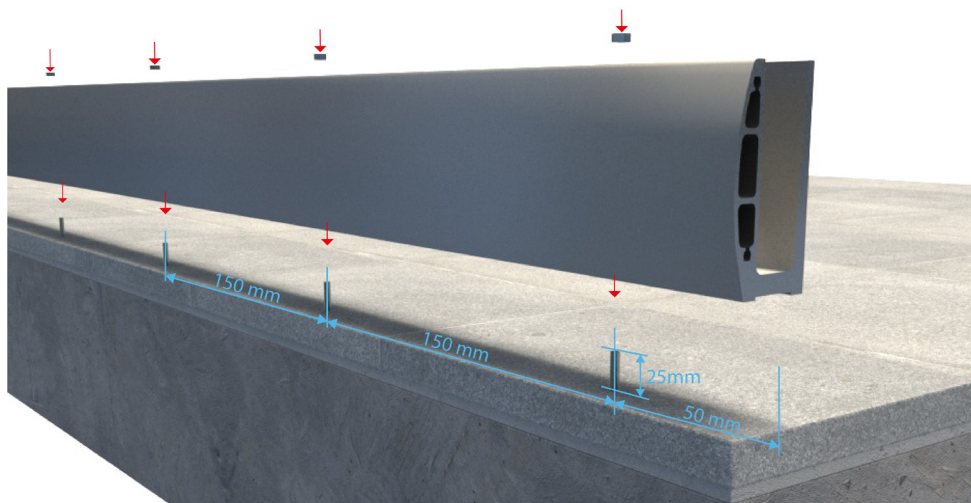

2. Insert the gasket into the outer face of the Railing profile.

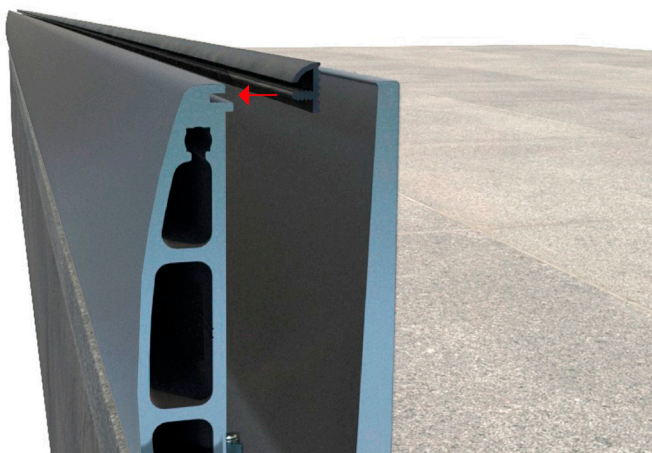

3. Insert the glass seats respecting the position and distances marked on the detail.

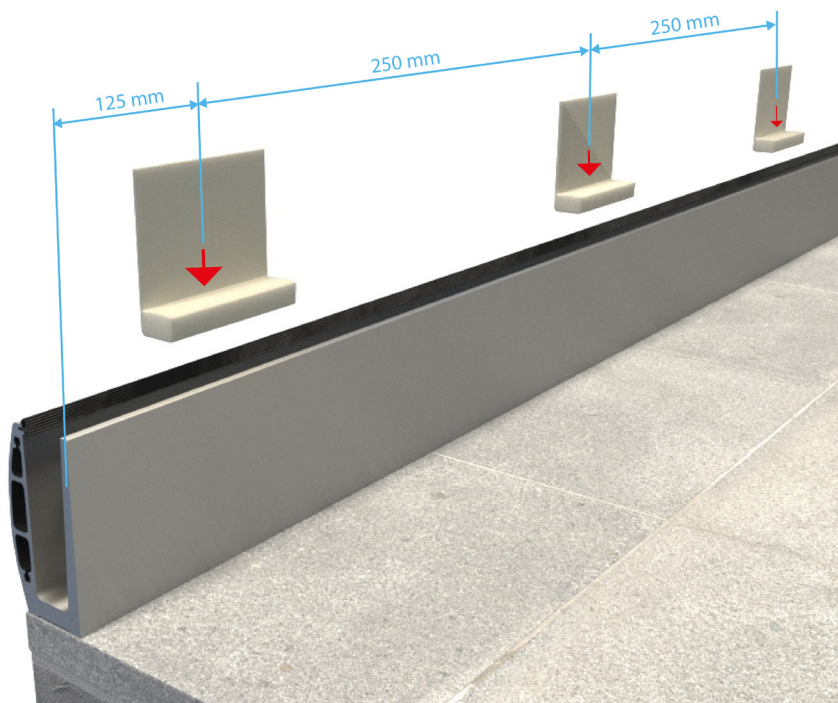

4. Insert the glass panels leaving a gap of 10mm between them, using the neoprene pieces to cover the Railing profile space between the panels.

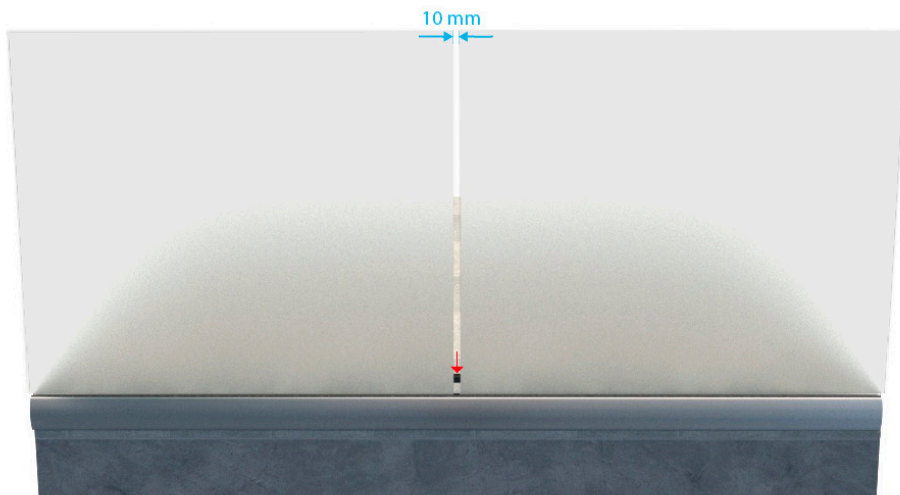

5. The fixing shims are pressed in and centred on the pre-installed seats.

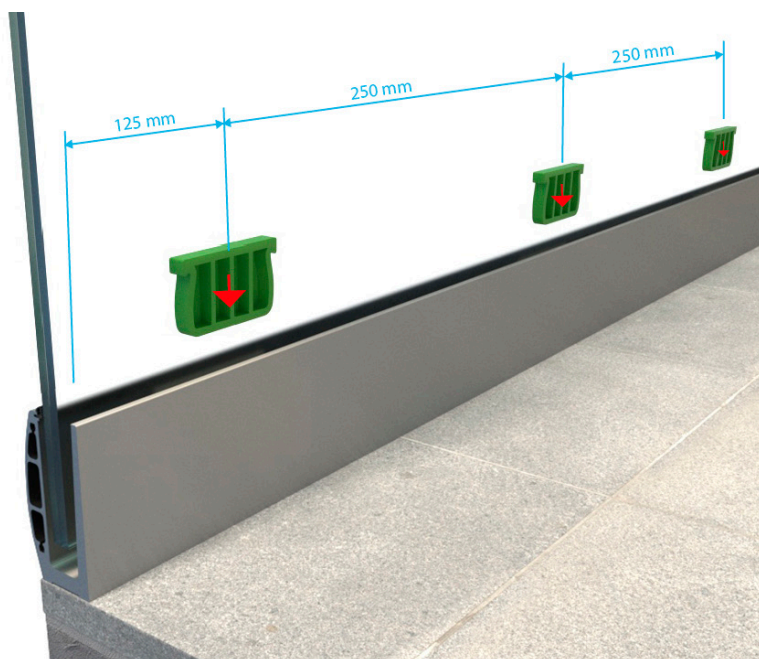

6. Press in the seals on the inside face of the Railing profile, previously sectioned to adapt it to the thickness of the installed glass.

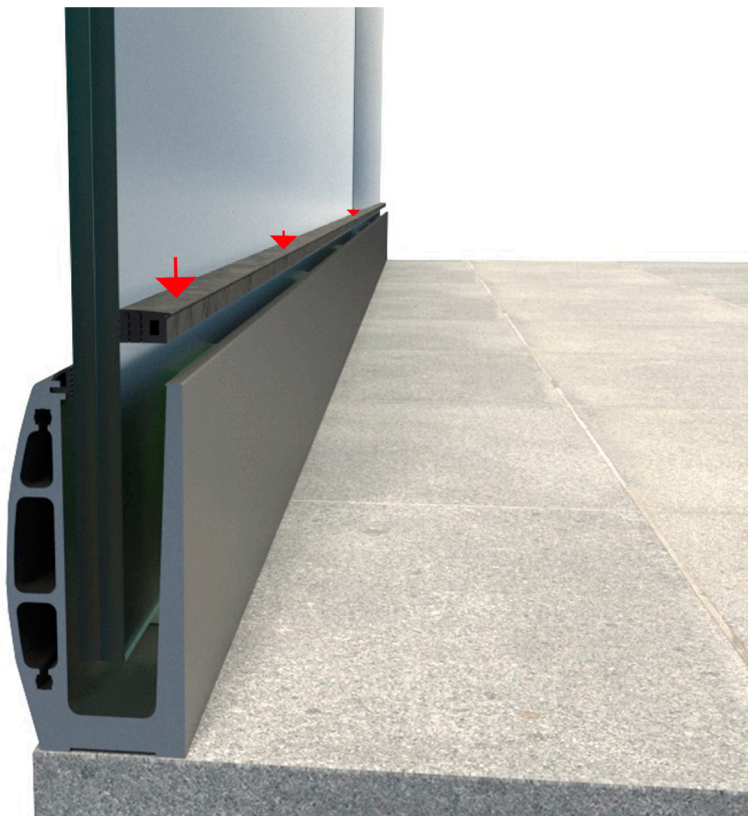

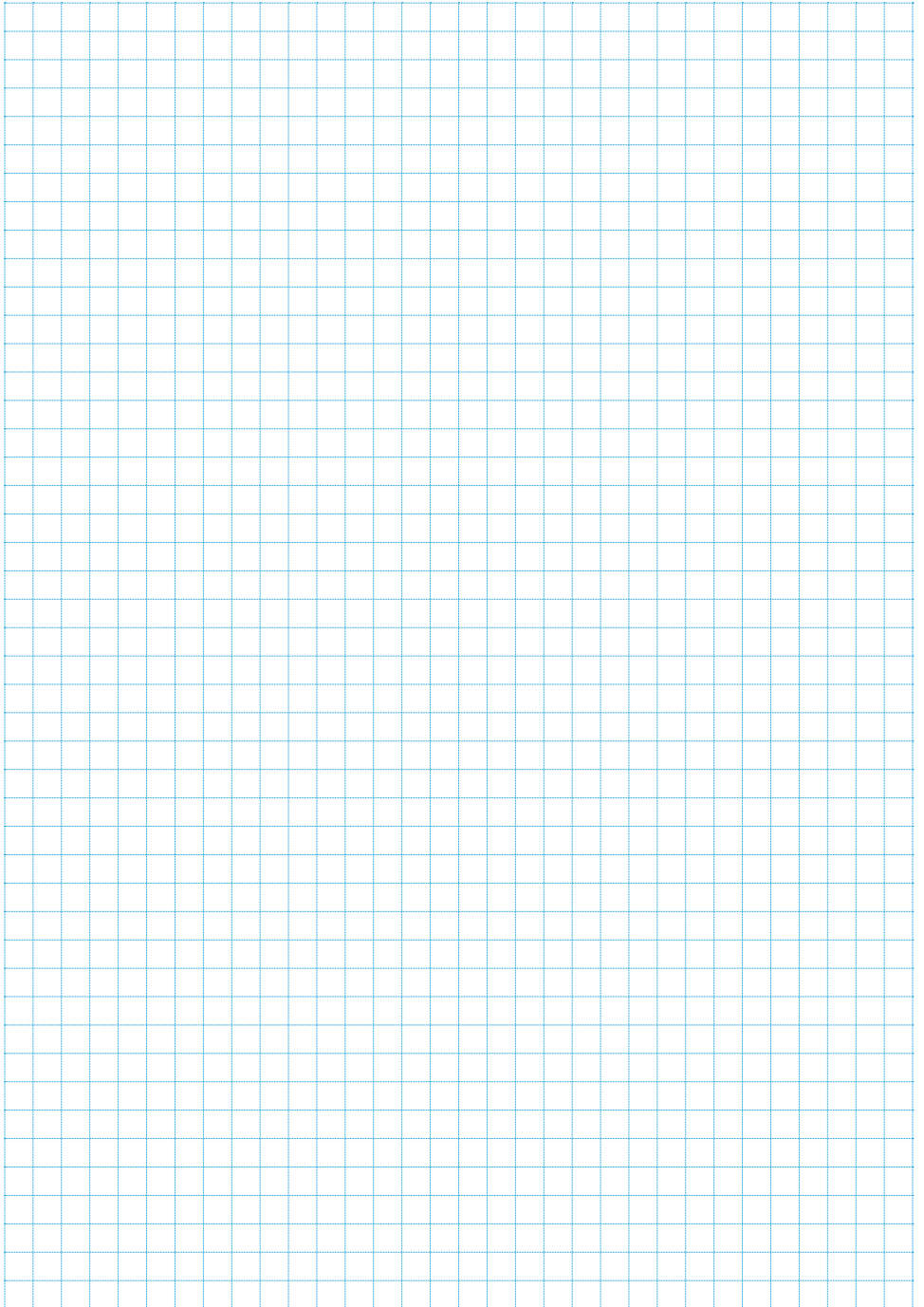

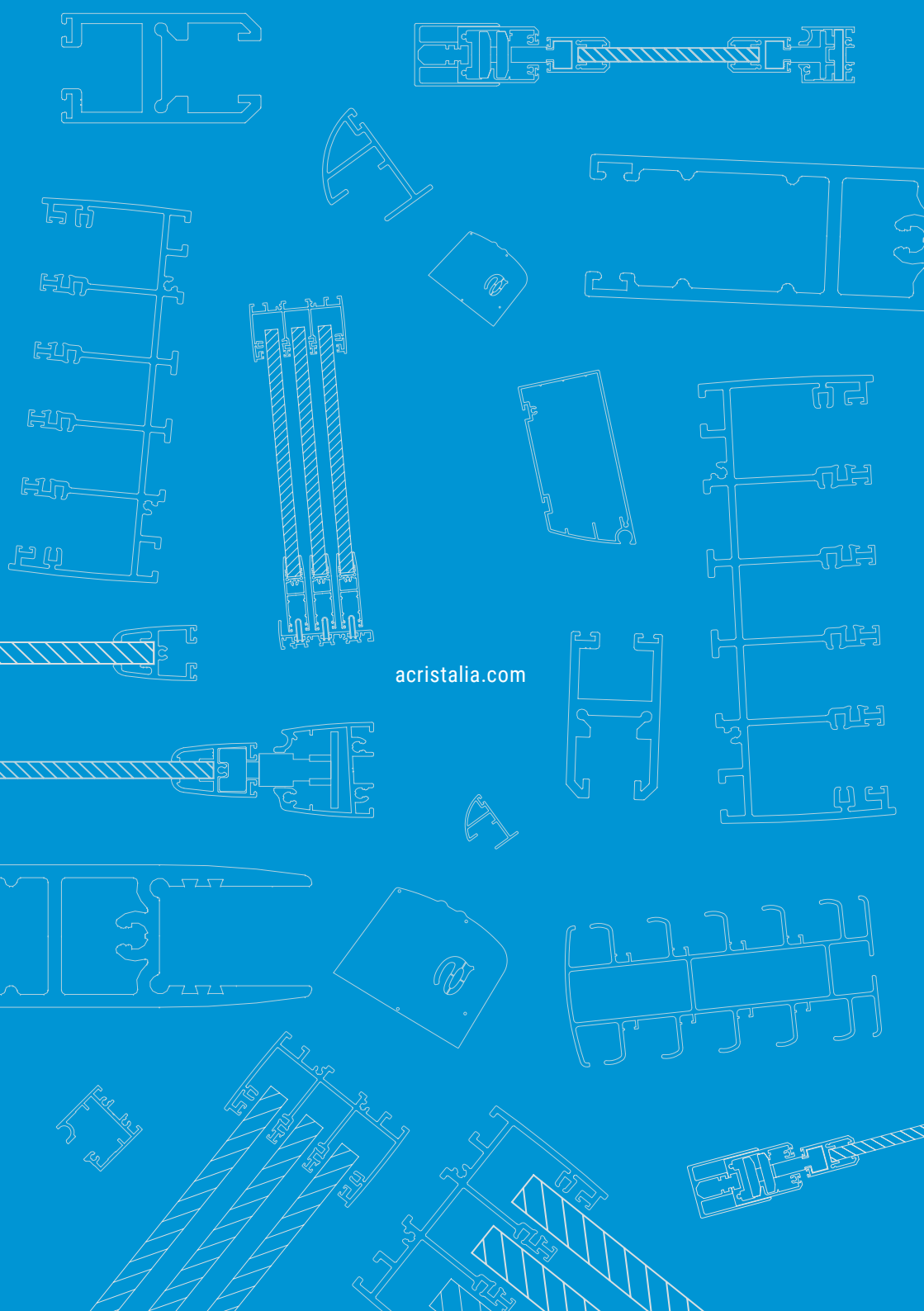

acristalia.com